

ON-BOARD GPS CLOCK MONITORING FOR SIGNAL INTEGRITY*

Marc Weiss
Time and Frequency Division
National Institute of Standards and Technology
325 Broadway, Boulder, Colorado 80305, USA
E-mail: mweiss@boulder.nist.gov

Pradipta Shome
Navigation Services Division, Air Traffic Organization
Federal Aviation Administration
Washington, DC 20591, USA
E-mail: pradipta.shome@faa.gov

Ron Beard
Navy Center for Space Technology
U.S. Naval Research Laboratory
Washington, DC 23075, USA
E-mail: ronald.beard@nrl.navy.mil

Abstract

Navigation signal integrity is paramount for aviation and safety of life services. Hitherto, GPS signal anomaly alerting has been provided primarily by ground-based augmentations. Significantly improved navigation signal integrity and quality may be accomplished by on-board detection and correction, within stringent time-to-alert limits. In this way, most GPS signal errors, of which the timekeeping system anomalies are the major source, could be eliminated. It would then be possible to provide signal integrity innately from the source constellation to specified service category levels that are enhanced to meet the integrity metrics of hazardously misleading information, time-to-alert, availability, continuity, and accuracy. The method is to continuously monitor multiple atomic frequency standards with time-difference measurements against each other on-board the satellites, using existing components present in GPS architecture in a method similar to that routinely done in timing labs throughout the world.

We focus in this paper on the issue of detecting and alleviating GPS clock anomalies by use of actual data illustrating frequency breaks in GPS clocks. These frequency breaks are derived from data taken in ground tests of Block IIR and Block IIF clocks. We also include some frequency breaks derived from on-orbit data. Using these data, we discuss how on-board measurements could be used to detect and mitigate problems, while also meeting stringent time-to-alert limits, such as 6 s or shorter.

* Contribution of U.S. government, not subject to copyright.

INTRODUCTION: SIGNAL INTEGRITY

A key requirement, signal integrity for aviation and other safety critical services, has several components, such as the time-to-alert (TTA), probability of hazardously misleading information (HMI), service availability, and continuity. TTA refers to the necessity of providing timely warning to the users when the system is degraded and should not be used. HMI faults could result from the failure to detect a broadcast of misleading information or a failure to broadcast an alarm about misleading information within the TTA. High signal service availability with continuity, along with attributes mentioned above, are required for dependable operation. Anomalous behavior of GPS clocks has been shown to be the major source of GPS HMI. This paper discusses the use of on-board clock monitoring as a means of alleviating this problem.

The current GPS by itself does not provide adequate levels of integrity, continuity, and time-to-alert requirements to permit primary reliance for safety-of-life applications. Augmentation systems are being developed and deployed to address some of these shortcomings [1], but inherent aspects of the current architectures make it difficult to achieve required performance levels, as embodied in the RTCA standards [2,3]. An important objective for future generations of satellite-based navigation is to meet and exceed the service guarantees of presently provided radio navigation aids, such as the instrument landing system (ILS), the VHF omnidirectional radio range (VOR), and Distance measuring equipment (DME) [4]. Thus, overcoming the limitations of ground-based augmentation systems and providing service quality consistent with FAA standards is a primary requirement of a next-generation GPS system.

We discuss one solution to this dilemma: an on-board, satellite-based integrity monitoring system, proposed by some authors [5-7]. The most effective monitor of the satellite signals would be at the source, on-board, where the signals are generated. This proximity would allow rapid failure detection and alerting by integrating fault detection and alerting capabilities within the satellite platform, where most of the anomalies arise, as revealed by the Integrity Failure Modes and Effects Analysis (IFMEA) study [8, 9]. The necessary features of such a monitoring service have been described [10] and could be implemented on a space-based platform.

Because the satellite clock signal is the basis for all other derived signals, detecting and removing clock anomalies eliminates many causes of signal aberration. Precisely monitoring clock signals normally requires a more stable reference signal. However, a rigorous approach, consistent with exacting integrity criteria, is to evaluate the performance of atomic standards by combining precise phase or time comparison between multiple clocks of similar type.

CLOCK ANOMALY DETECTION

Fundamentally, GPS navigation works by providing synchronized signals from known locations in space. Both the signal synchronization and the satellite positions that users actually receive are predictions that have been uploaded to the satellites typically as much as 24 hours earlier. While these data sets are currently uploaded nominally once per day to each satellite, contingency uploads are accomplished more often. Cross-link data transmissions have been considered as a means of shortening the period between uploads. With this method, the ground control station uploads the data for the entire constellation to one satellite. The cross-link communication system then propagates the respective data to each member of the constellation. These predictions are based on pseudo-range measurements made at ground-based monitor stations. Nevertheless, a clock anomaly must be alerted within a few seconds for the most stringent requirements of aircraft navigation. The Time-to-Alert (TTA) for the so-called Category I, II, and III

levels for precision approach is in Table 1. Current methods require ground-based augmentation systems to meet this need.

Table 1. RTCA standards for aviation integrity.

Phase of Flight	Accuracy	Integrity			Continuity Probability	Availability	
	(95% error)	Time to Alert	Alert Limit	Prob (HMI)	(Loss of Navigation)	Threshold	Objective
LPV	H: 16.0 m V: 6.0-4.0 m *	6 s	H: 40 m V: 35 m	$1-2 \times 10^{-7}$ /approach	$1-8 \times 10^{-6}$ / 15 sec	0.99	0.99999
APV	H: 16 m V: 7.6 m	6 s	H: 556 m V: 20 m	2×10^{-7} /approach	5×10^{-5} /hour	0.99	0.99999
Cat I Precision Approach	H: 16 m V: 4.0-7.6 m	6 s	L: 40 m V: 10-12 m	2×10^{-7} /approach	5×10^{-5} /hour	0.99	0.99999
Cat II Precision Approach	H: 6.9 m V: 2.0 m	2 s	H: 17.3 m V: 5.3 m	2×10^{-9} /approach	4×10^{-6} / 15 s	0.99	0.99999
Cat IIIa Precision Approach	H: 6.0 m V: 2.0 m	1-2 s	H: 15.5 m V: 5.3 m	2×10^{-9} /approach	L: 2×10^{-6} /30 s V: 2×10^{-6} /15 s	0.99	0.99999

Continually comparing clocks on-board satellites could provide dependable measurements to detect impending and actual clock signal failure, meeting the most stringent TTA requirements directly from the satellites. To meet these requirements, an accurate measurement system measuring multiple clocks simultaneously is a key. A measurement rate significantly faster than a time-to-alert requirement would be necessary for redundancy in this critical system. For example, measuring at a 10 Hz rate would allow repeated measurements to increase certainty within a 6 s TTA window. For isolation of the fault, at least three independent sources are required for majority voting.

This on-board monitoring capability would provide an immediate detection of anomalies in the on-line clock and provides a means for improved Continuity and Availability. The resulting status could be inserted into the navigation message for direct broadcast to the users and to the ground-segment monitoring stations, thereby providing a real-time alerting capability to the system. The data associated with the fault indication could also be telemetered to the control segment for diagnostic and remedial actions.

CLASSIFICATIONS OF CLOCK ANOMALIES

Achieving integrity and time-to-alert requirements for aviation and space requires the ability to detect true anomalies and false alerts with high probability to avoid occurrence of hazardously misleading information (HMI). Clock systems, such as the atomic standards on GPS, commonly experience anomalies and deviations that can be damaging from an integrity perspective. Deviations seen in timing systems include:

- occasional bad or outlier points,
- phase jumps in the clock system that later return to stable or predictable values,
- phase jumps in the clock system that do not return to predicted values,
- frequency deviations that return to predicted values, and
- true frequency steps that remain in the clock performance.

These anomalous effects may happen singly or in combination, suddenly, or over a period of time. Such serious situations related to satellite clock anomalies can be resolved by detection of these aberrations on board, where the clock's behavior can be monitored in real time without additional noise or errors added by communication and measurement from the ground. To this end, either redundant frequency standards on board, use of cross-link ranging measurements, or both are necessary.

ON-BOARD SATELLITE CLOCK COMPARISONS

At present in the GPS Block IIR satellite, a comparison of the on-board atomic frequency standard (AFS) and voltage-controlled crystal oscillator (VCXO) is accomplished at the subsystem known as the Time Keeping System (TKS) [11,12]. The interaction between the VCXO and the atomic standard has been studied by a simulation of the control loop. The resulting stability performance was studied by Wu [13,14]. The results show that the performance of a TKS comparison system will be dominated by the VCXO stability to a period possibly over 1000 s. This short-term noise will affect the system performance as well as the ability to predict the clock values. In addition, the stability of the VCXO is worse than the AFS after about 60 s.

To mitigate these shortcomings, multiple atomic frequency standards (AFS) can be inter-compared by running them simultaneously and measuring their differences. At least two AFS should be compared on-board a satellite. When two AFS on board show a difference from prediction exceeding an integrity threshold, the question of which clock has failed is indeterminate. Thus, the system must respond with an integrity failure alert to provide fail-safe capability. A comparison of three or more AFS could provide majority voting logic to determine the failed system and switch to a properly functioning clock. This would provide fail-operational capability, increasing availability and continuity. Additionally, cross-link ranging could possibly be used to provide additional AFS comparisons beyond, perhaps, two AFS compared on board. This would provide failure detection on the satellite leading to fail-safe operation, with cross-link ranging supporting failure recovery and continued operation. This dual approach provides some redundancy and risk mitigation, since a cross-link system might have less chance of reliable success than an on-board measurement system. Such a system might support TTA requirements, but there might be a delay in recovery leading to less support of continuity and availability requirements.

Regardless of how clocks are monitored in space, clock stability between ground updates must be good enough to accurately evaluate the transmitted signals and provide automatic integrity monitoring with virtually no false alerts from the combined system. With three running, on-board AFSs, occasional breaks of the error threshold can be allowed if the system can be assured of transfer to another AFS within a period shorter than the required TTA. With only two AFSs on board running and measured, the frequency standards must be stable enough for performance well below the required peak error threshold between uploads. The period between uploads is currently nominally 1 day. Studies into decreasing the interval between updates have been conducted by the GPS III teams, particularly by using cross-link data transfer.

Shortening the update interval for integrity considerations is dependent upon the cross-link data system operating with reliability compatible with integrity requirements. For example, for category I precision

approach (CAT-I), the probability of a navigation message data anomaly should be $< 10^{-7}$. The capability of the system to maintain integrity monitoring will depend to a degree upon the update interval that can be supported by clock stability. For longer intervals such as approaching a day, a more stable clock, which could maintain the integrity threshold time offset error from prediction at a day, is required for GPS III. Such clocks would also need a suitable on-board measurement system for comparison, as discussed below.

ADVANCED DUAL-MIXER MEASUREMENT SYSTEM

Direct inter-comparison and resolution can be precisely performed by the use of the dual-mixer technique, shown in Figure 1 below. The resolution of a system such as this can be shown to be considerably more precise than a phase meter only approach [15]. In addition, such a scheme injects no noise into the timing chain to degrade the stability characteristics. Dual-mixer technology is discussed elsewhere [15] and summarized here. The effective down-conversion gain of the measurement is the ratio of the nominal frequency, ν_0 , divided by the beat frequency $\Delta\nu$. If the nominal frequency is $\nu_0 = 10$ MHz and the beat frequency $\Delta\nu = 10$ Hz, then the down-conversion gain is 1×10^6 . If the time difference of the beat signal, Δx_{beat} , is measured with a Time-Interval Counter (TIC) having a resolution of 20 ns, the measurement of clock time difference, Δx , implies an equivalent theoretical resolution of 20 fs. While the hardware

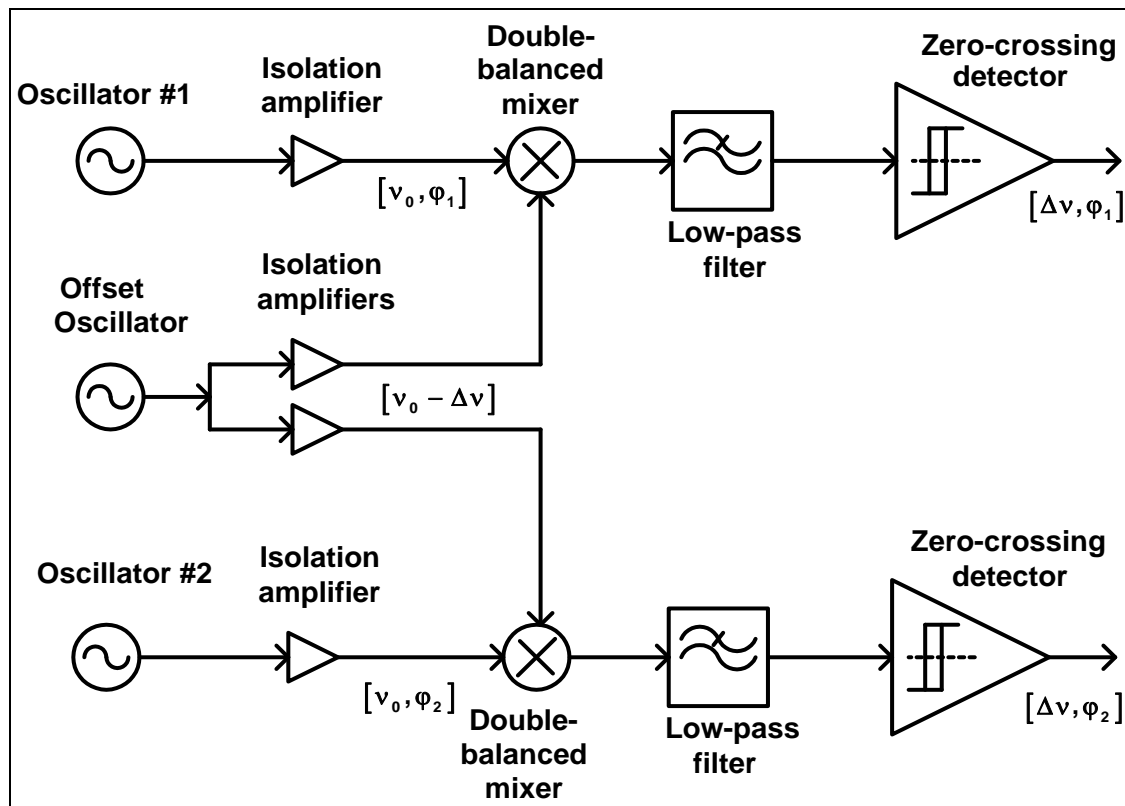

Figure 1. Dual mixer technique for phase measurement.

realization of this mathematical idealization may have effects that limit the accuracy, nevertheless, the dual-mixer approach provides a high-accuracy measurement system that allows the characterization of AFS performance in space. There are many options for implementation with current digital technology, which limit hardware distortions and optimize weight, power, and cost [16].

The basic configuration of the dual-mixer shown above can be extended to measure three or more oscillators simultaneously.

IMPACT OF FREQUENCY STEPS ON SIGNAL INTEGRITY

The Allan and Hadamard Variances are typically used to describe the stability of atomic frequency standards. However, neither is well suited for showing the effects of widely spaced frequency breaks. This is because these variances would ideally quantify the noise levels of the test clocks over an infinitely long sample period. Breaks such as the ones experienced in the GPS Block IIR and IIF clocks will have little effect over long sample periods of the variances. Variances calculated over relatively short periods of time that include one or more frequency breaks will show some degradation.

Another way to look at the effects is in terms of unexpected phase runoffs. A frequency break of 1×10^{-13} would result in 8.6 ns of time error (about 3 m of range error) over 24 hours. In normal operations, the GPS Control Segment could do an upload to correct the error. Without an upload, that error would continue to propagate. Larger frequency breaks could also cause time errors exceeding the FAA integrity limits. Weiss, Masarie, Shome, and Beard have investigated this using the Block IIR life test data [17,18], as we discuss below.

The integrity failure threshold would be a value for range error that should not be exceeded without an integrity alert. For our analysis, we take the value of 0.7 m, as specified in the GPS System Specification [19], as a somewhat reasonable value to provide aircraft integrity alerting for precision approach. In the Figure 2 below, we take the requirement of 0.7 m and compare it to the effect produced by frequency steps. The frequency steps in the plots above would have crossed the 0.7 m threshold after a few hours. Consequently, they will need to be detected and corrected. Risk mitigation would suggest developing a clock that would not do this.

INTEGRITY BOUND AND THE CLOCK STABILITY MEASUREMENT

A number of dependent factors need to be considered for trade-offs and accommodation, when considering clock monitoring for anomaly detection and integrity assurance. First, note that atomic clocks are fundamentally frequency devices, and could at best provide a Gaussian distribution of deviations around its true frequency, with a noise spectrum consistent with a white-noise model of frequency modulation. Even in this ideal case, white noise in frequency would integrate to a random walk in the time of the clock. Thus, even an ideal clock would randomly walk off from prediction at some rate.

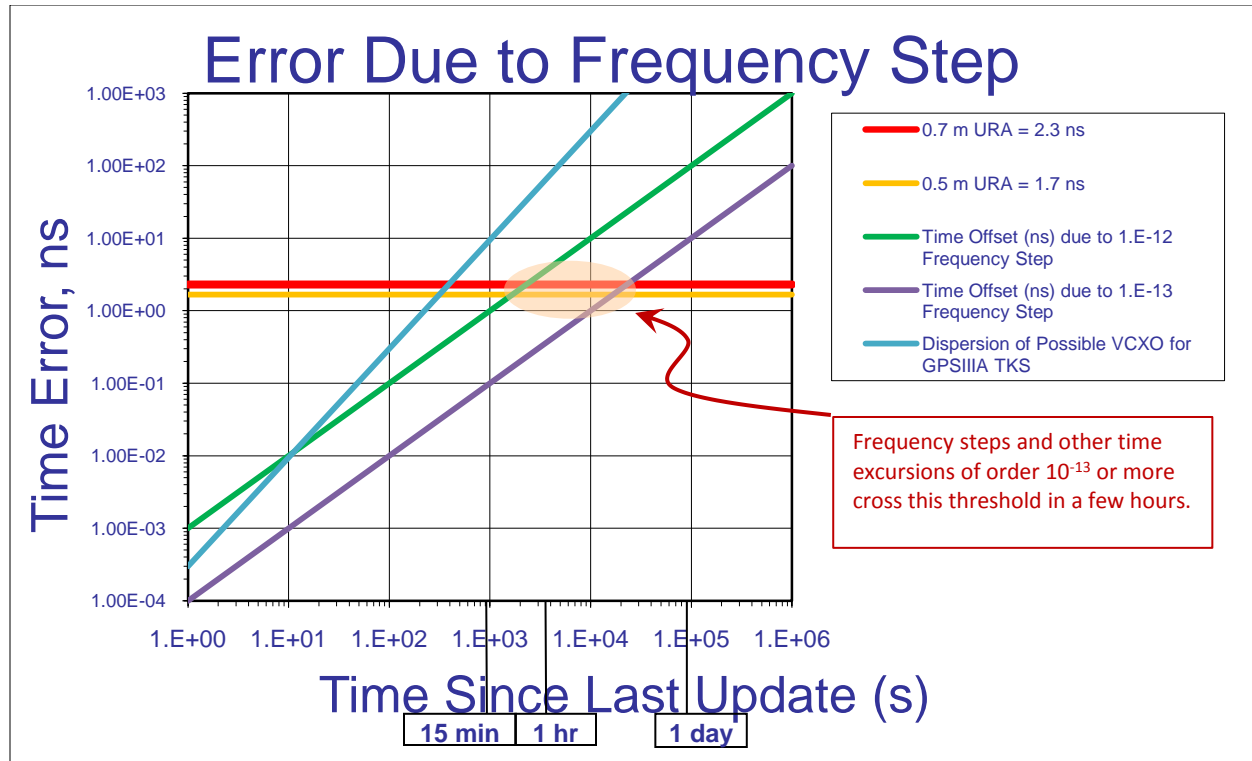

Figure 2. Expected clock deviations due to frequency errors vs. update interval.

Heightening this problem is the fact that GPS atomic frequency standards rarely produce a Gaussian distribution of deviations from prediction. This includes the rubidium vapor cell standard design in use for Blocks IIR and IIF and planned for Block III. Distribution of clock deviations depends on the statistics that characterize both the steady-state performance of the clock, as well as occasional frequency departures that are not steady-state. It may be that a good model involves separate steady-state statistics from anomalous behaviors in operating clocks. A complete evaluation of this problem for GPS clocks needs to be done.

With a Gaussian model, a probability of 10^{-7} , as required for CAT-I, is reached by allowing data within 5.33 standard deviations. Since the existing clock data are not Gaussian, and since we are planning for the performance of clocks not yet made, the resulting distribution cannot be known. To allow some analysis of clock requirements relative to an integrity error threshold, we select a value of 10 times the deviation as a reasonable guess.

A second concept crucial to understanding on-board clock monitoring is the relationship between clock stability, or predictability, and the update interval. The longer the update interval, the more stringent are the requirements for clock performance. For integrity monitoring, the update interval must be realizable with the stringent reliability requirements for aviation integrity. Advanced cross-link data systems may achieve uploads every hour or even every 15 minutes, but perhaps not reliably enough in a new system. Given the current rate of one upload per day, it is prudent to design to meet the present baseline until future systems are proven.

A third assumption is that of the integrity failure threshold. This would be a value for range error that should not be exceeded without an integrity alert. For analysis here, we again take the value of 0.7 m, as

specified in the GPS system specification [19], as a somewhat reasonable value to provide aircraft integrity alerting for precision approach.

Figure 3 combines these concepts to illustrate their interaction graphically. The figure compares the deviation of various advanced clocks with 1/10 of the required performance to meet a 0.7 m prediction error threshold. The vertical axis is the Hadamard deviation of a clock, a statistic chosen because it aliases the linear frequency drift of a clock. Thus, assuming the drift can be removed operationally, we compare the predictability of clocks without drift. The horizontal axis is the time interval between updates. Thus, we see the stability of each clock as a function of the interval the clock would be required to hold performance. A clock supports the error threshold in the plot when its stability curve lies below the red line.

Thus, we see that all of the clocks illustrated lie below the ten-deviation requirement out to almost 1 day. This model implies that a more advanced clock would be required to support a true 1-day update period. The estimated IIF Rubidium Atomic Frequency Standard (RAFS) and the performance required for the Advanced Technology Atomic Frequency Standard (ATAFS) clocks lie below the red bound for a 15-minute update period and stay below out to about a half-day update period. With a more stable advanced clock, it would be possible to achieve the required stability with the present operational mode of 1-day update period.

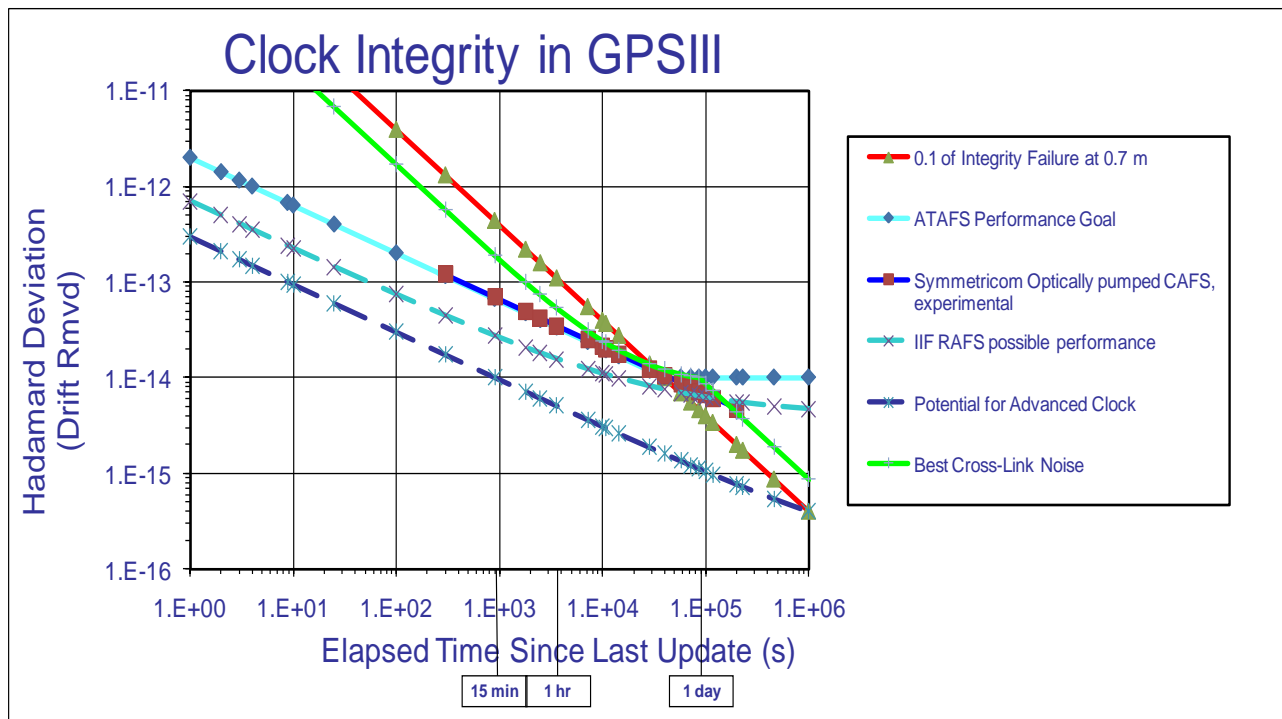

Figure 3. Clock stability and cross-link measurement in support of GPS III integrity. A clock holds stability in support of 0.7 m error threshold when its stability lies below the red line, as discussed in the text.

We see also in Figure 3 that an advanced cross-link ranging system could support a 1/10 of 0.7 m threshold by comparing clocks among adjacent satellites at update rates of up to 1/day. The noise of cross-link measurements may be closer to Gaussian than is clock noise. However, the speed of cross-link measurements, which is not addressed in this noise estimate, would have to be fast compared to the TTA.

SUMMARY OF GPS IIR FREQUENCY STEPS

NRL performed a life test of two GPS IIR RAFS units over a 7-year period ending in 2004. Both clocks were operated in a simulated space environment, and all available telemetry points were recorded. The 13.4 MHz outputs were continuously compared to the NRL reference clocks. Neither of the units failed in that test period, but both exhibited frequency steps. Unit serial number 28 started with a repeating sequence of positive and negative steps which lasted the first 4 years of the test (Figure 4). At that point, unit 28 experienced a 2×10^{-12} step and the pattern ended. It had another similar step a few months later.

The second IIR life test unit, serial number 30, also had frequency steps, but they were smaller, less frequent, and not periodic (Figure 5). As part of the life test, high resolution telemetry data were collected for both test clocks. For the periodic steps in RAFS 28, correlating changes were seen in the second harmonic and light telemetry monitors. It is interesting to note that many of the breaks occurred in a sequence of three distinct breaks over a period of several days. During the period between the first and third breaks, the frequency drift rate, aging, is different.

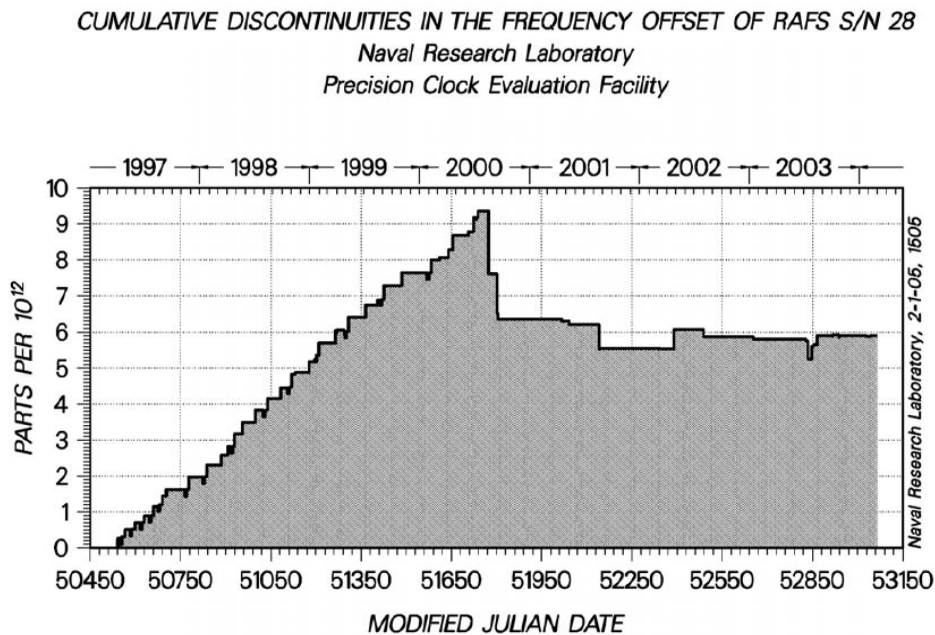

Figure 4. Cumulative discontinuities in the frequency offset of IIR RAFS S/N 28.

CUMULATIVE DISCONTINUITIES IN THE FREQUENCY OFFSET OF RAFS 30
 Naval Research Laboratory
 Precision Clock Evaluation Facility

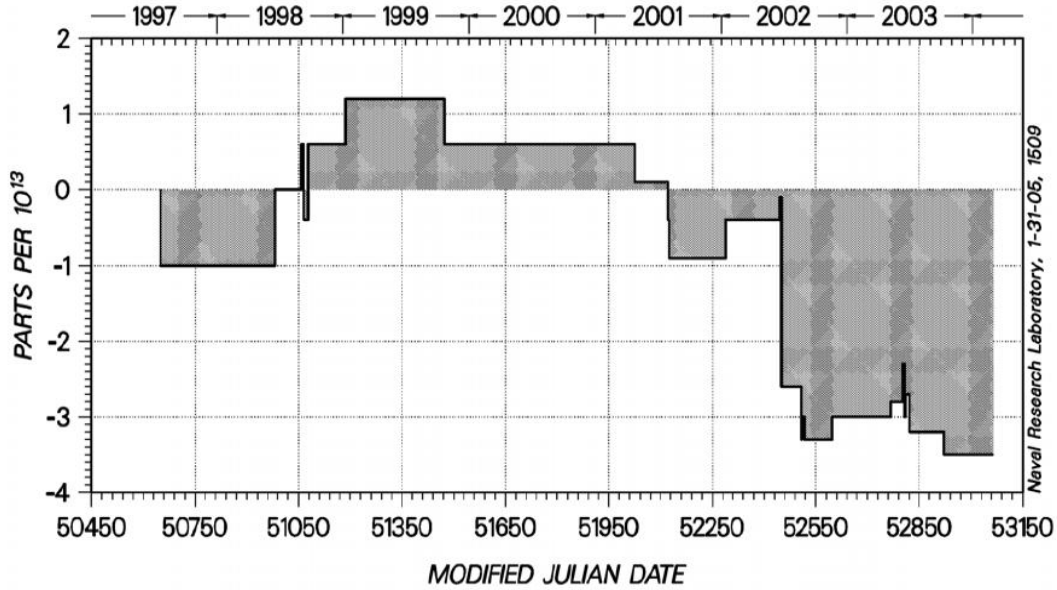

Figure 5. Cumulative discontinuities in the frequency offset of IIR RAFS S/N 30.

A preliminary study of peak deviation from prediction in the two GPS IIR life-test RAFS was done previously [18]. Over a period of 150 d, units 28 and 30 held predicted time as in Table 2 below. The deviations for serial number (S/N) 28 were due primarily to frequency steps, typically worse in negative values than in positive. For S/N 30, the deviations were largely due to the mean frequency not being at the center of the distribution. S/N 30 had a bimodal distribution of frequency deviations, a main one and a smaller one with a different mean value.

Table 2. Peak deviation from prediction in ns from 150 d of life-test data.

	S/N 28	S/N 30
15 minutes	1.5	0.4
1 hour	6	0.5
2 hours	12	0.7
4 hours	25	1.0
8 hours	50	1.5
1 day	150	4

SVN 43, the first successful IIR launch, displayed similar performance, as seen in the on-orbit data in Figure 6. Table 3 summarizes the Block IIR repetitive frequency breaks. It is difficult to observe these correlations in the on-orbit telemetry data, due to the limited resolution of the telemetry. To date, 24 Block IIR/IIRM clocks have been activated, with only the nine shown in Table 3 exhibiting frequency steps having a cyclic period.

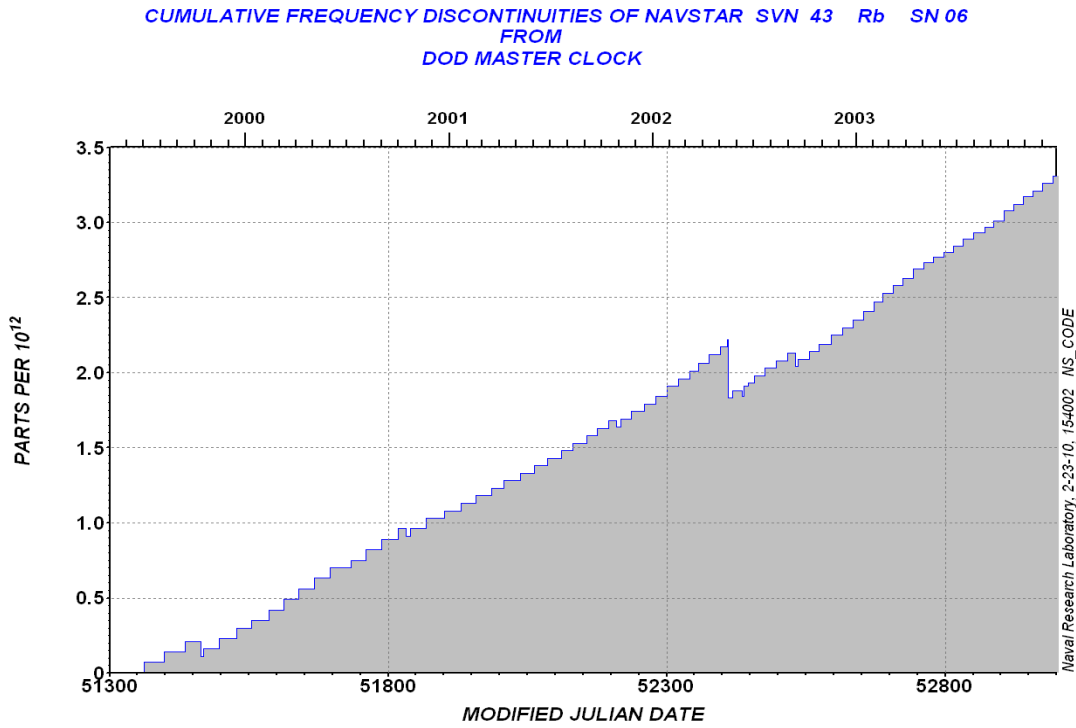

Figure 6. Cumulative discontinuities in the frequency offset of IIR RAFS S/N 06.

Table 3. Summary of Block IIR on-orbit repetitive frequency breaks.

Space Vehicle Number	Frequency Break Parts in 10(14)	Cyclic Period (days)	Plane
43	8	19	F
44	20	3	B
45	23	22	D
46	18	13	D
47	50	10	E
53	20	15	C
54	15	28	E
57	23	12	C
59	7	9	C

Historically, frequency steps in rubidium clocks are blamed on the rubidium lamp that creates the spectrally filtered light used to interrogate the rubidium atomic resonance. If a clock showed steps, replacing the lamp usually reduced the number of steps. However, there were no real criteria for determining a good lamp from a bad one other than operating it in a clock for a lengthy period. Even then, steps did occur, just at a lower rate or amplitude.

BLOCK IIF RAFS LIFE TEST CLOCK BEHAVIOR

Several changes have been made in the design of the Block IIR clock for Block IIF. In addition to modifying the clock to output 10.23 MHz, there were also changes to the gas mixture used in the rubidium lamp and other relatively small changes in the physics unit. Two IIF RAFS units are currently in life-test at facilities at NRL. They have both shown frequency steps at 18 months into the test period. The largest step of the six steps reported on clock serial number 5 was $+7.0 \times 10^{-14}$. For serial number 25, the two steps were reported with the larger being -3.5×10^{-14} . These are clearly much smaller than what was seen in the IIR test. Neither clock is showing any pattern to its steps. Figure 7 shows the steps for both clocks. Both of the steps on unit 25 showed apparent correlation between the telemetry and the frequency steps. An example is MJD 55192, where the second harmonic shifted at the same time the frequency stepped. There was no change in the light monitor. The last step on each clock was associated with a change in chamber pressure due to vacuum pump maintenance.

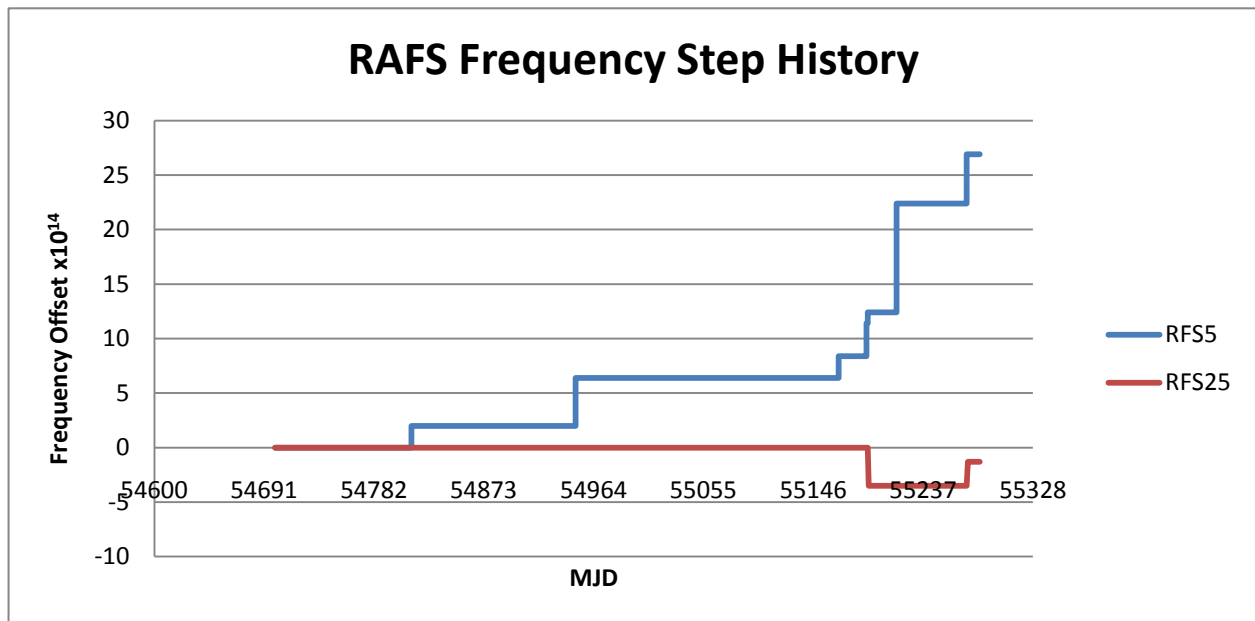

Figure 7. Frequency step history for IIR RAFS, S/N 5 and 25.

The IIF RAFS life test has shown another, more unusual frequency change characteristic. RAFS 5 experienced a change of drift rate over a period of several days, resulting in a net frequency shift of about $+1 \times 10^{-13}$. The clock had been drifting negative at $6.9 \times 10^{-14}/\text{day}$ when it shifted to a drift rate of $+1 \times 10^{-14}/\text{day}$. Two days later, it shifted back to the initial drift rate. What differentiates this behavior from a typical frequency step is that it takes several days to complete the event. The phase plot, Figure 8, would normally show a sharp point at the point where the frequency changes.

An on-board system would be able to detect such irregular changes in behavior and compensate accordingly to maintain timekeeping system performance within the required invariability for long-term signal integrity.

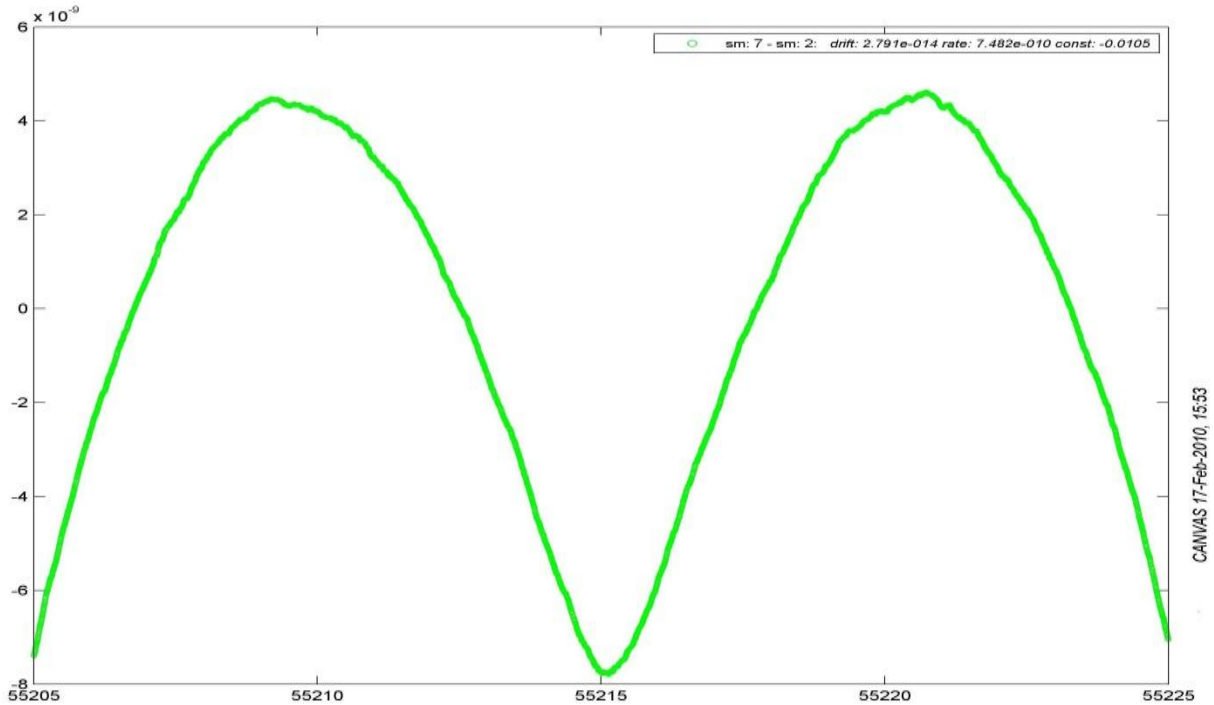

Figure 8. Phase change reversal. For IIR RAFS S/N 5.

CONCLUSIONS

We have presented concepts for GPS signal integrity assurance directly from the satellites, where the signal is generated. A cautious development approach might yield considerable advantages for users requiring integrity assurance.

Achieving GPS III signal integrity requires a robust cross-link system, more stable atomic frequency standards, or both for risk mitigation. Providing Cat-I directly from GPS requires providing automatic anomaly detection on board the space vehicle (SV). Key to this function is the stability of the on-board clock between uploads, as well as providing an on-board measurement system capable of precisely measuring multiple clocks.

Currently, the Control Segment normal operational mode is to upload from the ground once per day. Reducing this upload interval significantly would require a more precise and reliable cross-link system. However, to depend on cross-link uploads in order to maintain integrity would require a high degree of robustness for the new cross-link system.

The concept could be validated by a relatively modest development effort demonstrating that a time-keeping system could be employed to support Cat I criteria. This system could continue to depend on 1-

day uploads, but with higher accuracy, signal integrity, and quality, while providing enhanced robustness, redundancy, and risk mitigation.

REFERENCES

- [1] L. Vidarsson, S. Pullen, G. Green, and P. Enge, 2001, “*Satellite Autonomous Integrity Monitoring and its Role in Enhancing User Performance*,” in Proceedings of the ION GPS 2001 14th International Technical Meeting of the Satellite Division of the Institute of Navigation, 11-14 September 2001, Salt Lake City, Utah, USA (Institute of Navigation, Alexandria, Virginia), pp. 690-702.
- [2] “*Minimum Operational Performance Standards for GPS/WAAS Airborne Equipment*,” RTCA SC-159, DO-229, 6 October 1999.
- [3] “*Minimum Aviation System Performance Standards for LAAS*,” RTCA-159, DO-245, 28 September 1998.
- [4] National Airspace System Requirements Specification, NAS-SS-1000, Federal Aviation Administration, Washington, D.C., 1991.
- [5] A. Bruce, A. Van Dierendonck, A. Jakab, J. Wiebe, and B. Townsend, 2000, “*Detection of GPS Satellite Signal Failures in Satellite Based Augmentation Systems*,” in Proceedings of the ION GPS 2000 13th National Technical Meeting of the Satellite Division of the Institute of Navigation, 19-22 September 2000, Salt Lake City, Utah, USA (Institute of Navigation, Alexandria, Virginia), pp. 189-198.
- [6] R. Wolf, 2000, “*Onboard Autonomous Integrity Monitoring Using Intersatellite Links*,” in Proceedings of the ION GPS 2000 13th National Technical Meeting of the Satellite Division of the Institute of Navigation, 19-22 September 2000, Salt Lake City, Utah, USA (Institute of Navigation, Alexandria, Virginia), pp. 1572-1581.
- [7] McGraw and Murphy, “*Safety of Life Considerations for GPS Modernization Architectures*,” in Proceedings of the ION GPS 2001 14th National Technical Meeting of the Satellite Division of the Institute of Navigation, 11-14 September 2001, Salt Lake City, Utah, USA (Institute of Navigation, Alexandria, Virginia), pp. 632-640.
- [8] K. Van Dyke, K. Kovach, J. Kraemer, J. Lavrakas, J. P. Fernow, J. Reese, and N. Attallah, 2003, “*GPS Integrity Failure Modes and Effects Analysis*,” in Proceedings of the ION GPS 2003 16th National Technical Meeting of the Satellite Division of the Institute of Navigation, 22-24 January 2003, Anaheim, California, USA (Institute of Navigation, Alexandria, Virginia), pp. 689-703.
- [9] K. Van Dyke, K. Kovach, J. Lavrakas, and B. Carroll, 2004, “*Status Update on GPS Integrity Failure Modes and Effects Analysis*,” in Proceedings of the ION GPS 2004 National Technical Meeting of the Satellite Division of the Institute of Navigation, 26-28 January 2004, San Diego, California, USA (Institute of Navigation, Alexandria, Virginia), pp. 92-102.
- [10] J. Lavrakas and J. W. Broomfield, 2003, “*Defining the Elements of a Civil GPS Monitoring Service*,” in Proceedings of the ION GPS 2003 16th National Technical Meeting of the Satellite Division of the Institute of Navigation, 22-24 January 2003, Anaheim, California, USA (Institute of Navigation, Alexandria, Virginia), pp. 683-688.

- [11] J. Petzinger, R. Reith, and T. Dass, 2003, “*Enhancements to the GPS block IIR timekeeping system,*” in Proceedings of the 34th Annual Precise Time and Time Interval (PTTI) Systems and Applications Meeting, 3-5 December 2002, Reston, Virginia, USA (U.S. Naval Observatory, Washington, D.C.), pp. 89-107.
- [12] J. Phelan, T. Dass, G. Freed, J. Rajan, J. D’Agostino, and M. Epstein, 2005, “*GPS Block IIR clocks in space: Current performance and plans for the future,*” in Proceedings of the 2005 Joint International Frequency Control Symposium and Precise Time and Time Interval (PTTI) Systems and Applications Meeting, 29-31 August 2005, Vancouver, Canada (IEEE 05CH37664C), pp. 19-25.
- [13] A. Wu, 1997, “*Performance evaluation of the GPS block IIR time keeping system,*” in Proceedings of the 28th Annual Precise Time and Time Interval (PTTI) Systems and Applications Meeting, 3-5 December 1996, Reston, Virginia, USA (U.S. Naval Observatory, Washington, D.C.), pp. 441-453
- [14] K. L. Senior, J. R. Ray, and R. L. Beard, 2008, “*Characterization of periodic variations in the GPS satellite clocks,*” **GPS Solutions**, **12**, no. 3, 211-225.
- [15] G. P. Landis, I. Galysh, and T. Petsopoulos, 2002, “*A New Digital Phase Measurement System,*” in Proceedings of the 33rd Annual Precise Time and Time Interval (PTTI) Systems and Applications Meeting, 27-29 November 2001, Long Beach, California, USA (U.S. Naval Observatory, Washington, D.C.), pp. 543-552.
- [16] S. Romisch, T.E. Parker, and S.R. Jefferts, 2010, “*Novel, All-Digital Phase Measurement System for Time Scales,*” in Proceedings of the 41st Annual Precise Time and Time Interval (PTTI) Systems and Applications Meeting, 16-19 November 2009, Santa Ana Pueblo, New Mexico, USA (U.S. Naval Observatory, Washington, D.C.), pp. 397-408.
- [17] M. A. Weiss, P. Shome, and R. L. Beard, 2007, “*GPS Signal Integrity Dependencies on Atomic Clocks,*” in Proceedings of the 38th Annual Precise Time and Time Interval (PTTI) Systems and Applications Meeting, 5-7 December 2006, Reston, Virginia, USA (U.S. Naval Observatory, Washington, D.C.), pp. 439-448.
- [18] M. A. Weiss, A. Masarie, and R. L. Beard, 2007, “*Peak Deviation from Prediction in Atomic Clocks,*” in Proceedings of the 2007 Joint Meeting of the IEEE International Frequency Control Symposium and the 21st European Frequency and Time Forum (EFTF), 29 May-1 June 2007, Geneva, Switzerland, pp. 1002-1007.
- [19] GPS III System Specification, SS-SYS-800D, Global Positioning Systems Wing, USAF.

